

**MICROPROCESSOR
OVERCURRENT and EARTH FAULT
RELAY**

TYPE

MC30-TR

OPERATION MANUAL



INDEX

1. GENERAL UTILIZATION AND COMMISSIONING DIRECTIONS	3
1.1 - Storage and Transportation	3
1.2 - Installation	3
1.3 - Electrical Connection	3
1.4 - Measuring Inputs and Power Supply	3
1.5 - Outputs Loading	3
1.6 - Protection Earthing	3
1.7 - Setting and Calibration	3
1.8 - Safety Protection	3
1.9 - Handling	3
1.10 - Maintenance	4
1.11 - Waste Disposal of Electrical & Electronic Equipment	4
1.12 - Fault detection and repair	4
2. GENERAL CHARACTERISTICS	5
2.1 - Power Supply	5
2.2 - Operation and Algorithms	6
2.2.1 - Reference Input Values	6
2.2.2 - Input quantities	6
2.2.2.1 - Mains Frequency (Freq)	6
2.2.2.2 - Phase Current inputs (I1)	6
2.2.2.3 - Earth Fault Current Input (Ion)	6
2.2.2.4 - Algorithm of the time current curves	7
2.2.3 - Time Current Curves IEC (TU1029 Rev.0)	8
2.2.4 - Time Current Curves IEEE (TU1028 Rev.0)	9
2.2.5 - Functions and Settings (Function)	10
2.2.5.1 - T> (F49) - Thermal Image protection level	10
2.2.5.2 - Thermal Image Curves (TU0445 Rev.0)	11
2.2.5.3 - I> (1F51) - First overcurrent protection level	12
2.2.5.4 - I>> (2F51) - Second overcurrent protection level	12
2.2.5.5 - IH (3F51) - Third overcurrent protection level	13
2.2.5.6 - Io> (1F51N) - First Earth Fault protection level	14
2.2.5.7 - Io>> (2F51N) - Second Earth Fault protection level	14
2.2.5.8 - IoH (3F51N) - Third Earth Fault protection level	15
2.2.5.9 - BF (F51BF) - Breaker Failure	15
2.2.5.10 - RTD - Remote Trip	15
2.2.5.11 - I.R.F. - Internal Relay Failure	16
2.2.5.12 - Osc - Oscillographic Recording	16
2.2.5.13 - Comm - Communication Parameters	17
2.2.5.14 - LCD - Display and Buzzer operation	17
3. LOGIC BLOCKING OF FUNCTIONS	18
3.1 - Blocking Outputs	18
3.2 - Blocking Inputs	18
4. OUTPUT RELAYS	18
5. DIGITAL INPUTS	19
6. SELFDIAGNOSTIC	19
7. RELAY MANAGEMENT	20
8. SIGNALIZATIONS	21
9. KEYBOARD BUTTONS	21
10. Serial Communication Port	22
10.1 - Main RS485 Serial Communication Port	22
10.2 - Communication Port on Front Face Panel	23
11. MENU AND VARIABLES	24
11.1 - Real Time Measurements	24
11.2 - Meas (Instantaneous Measurements)	24
11.3 - Counter (Operation Counters)	24
11.4 - LastTrip (Event Recording)	25
11.5 - R/W Set (Programming / Reading the Relay Settings)	26
11.5.1 - CommAdd (Communication Address)	26
11.5.2 - Time/Date (Time/Date)	26
11.5.3 - RatedVal (Rated Input Values)	26
11.5.4 - Function (Functions)	27
11.6 - RelayCfg (Relay Configuration)	29
11.7 - Commands	29
11.8 - Info&Ver (Firmware - Info&Version)	29
12. KEYBOARD OPERATIONAL DIAGRAM	30
13. PASSWORD	34
13.1 - MS-Com Password	34
14. MAINTENANCE	34
15. POWER FREQUENCY INSULATION TEST	34
16. CONNECTION DIAGRAM	35
17. OVERALL DIMENSIONS	35
18. DIRECTION FOR PCB'S DRAW-OUT AND PLUG-IN	36
18.1 - Draw-Out	36
18.2 - Plug-In	36
19. ELECTRICAL CHARACTERISTICS	37

1. GENERAL UTILIZATION AND COMMISSIONING DIRECTIONS

Always make reference to the specific description of the product and to the Manufacturer's instruction. Carefully observe the following warnings.

1.1 - Storage and Transportation

must comply with the environmental conditions stated on the product's instruction or by the applicable IEC standards.

1.2 - Installation

must be properly made and in compliance with the operational ambient conditions stated by the Manufacturer.

1.3 - Electrical Connection

must be made strictly according to the wiring diagram supplied with the Product, to its electrical characteristics and in compliance with the applicable standards particularly with reference to human safety.

1.4 - Measuring Inputs and Power Supply

carefully check that the value of input quantities and power supply voltage are proper and within the permissible variation limits.

1.5 - Outputs Loading

must be compatible with their declared performance.

1.6 - Protection Earthing

When earthing is required, carefully check its effectiveness.

1.7 - Setting and Calibration

Carefully check the proper setting of the different functions according to the configuration of the protected system, the safety regulations and the co-ordination with other equipment.

1.8 - Safety Protection

Carefully check that all safety means are correctly mounted, apply proper seals where required and periodically check their integrity.

1.9 - Handling

Notwithstanding the highest practicable protection means used in designing M.S. electronic circuits, the electronic components and semiconductor devices mounted on the modules can be seriously damaged by electrostatic voltage discharge which can be experienced when handling the modules.

The damage caused by electrostatic discharge may not be immediately apparent but the design reliability and the long life of the product will have been reduced. The electronic circuits reduced by M.S. are completely safe from electrostatic discharge (8 KV IEC 255.22.2) when housed in their case; withdrawing the modules without proper cautions expose them to the risk of damage.

- a. Before removing a module, ensure that you are at the same electrostatic potential as the equipment by touching the case.
- b. Handle the module by its front-plate, frame, or edges of the printed circuit board. Avoid touching the electronic components, printed circuit tracks or connectors.
- c. Do not pass the module to any person without first ensuring that you are both at the same electrostatic potential. Shaking hands achieves equipotential.
- d. Place the module on an antistatic surface, or on a conducting surface which is at the same potential as yourself.
- e. Store or transport the module in a conductive bag.

More information on safe working procedures for all electronic equipment can be found in BS5783 and IEC 147-OF.

1.10 - Maintenance

Make reference to the instruction manual of the Manufacturer ; maintenance must be carried-out by specially trained people and in strict conformity with the safety regulations.

1.11 - Waste Disposal of Electrical & Electronic Equipment

(Applicable throughout the European Union and other European countries with separate collection program).

This product should not be treated as household waste when you wish dispose of it. Instead, it should be handed over to an applicable collection point for the recycling of electrical and electronic equipment. By ensuring this product is disposed of correctly, you will help prevent potential negative consequence to the environment and human health, which could otherwise be caused by inappropriate disposal of this product. The recycling of materials will help to conserve natural resource.

1.12 - Fault detection and repair

Internal calibrations and components should not be altered or replaced.
For repair please ask the Manufacturer or its authorised Dealers.

Misapplication of the above warnings and instruction relieves the Manufacturer of any liability.

2. GENERAL CHARACTERISTICS

The MC is a very innovative and versatile line of Protective Relays which takes advantage of the long and successful experience coming from the M-Line.

The main features of the MC-Line relays are:

Compact draw-out execution for Flush Mounting or for assembly in 19" 3U chassis for 19" Rack systems.

User friendly front face with 2x8 characters LCD Display, four signal Leds, four keys for complete local management and 9-pin socket for local RS232 serial communication.

Four user programmable Output Relays. On request one of the Output Relays can be replaced by a Can Bus port for control of additional I/O modules.

Three optoisolated, selfpowered Digital Inputs.

RS485 communication port (independent from the RS232 port on front panel)

Totally draw-out execution with automatic C.T. shorting device.

Input currents are supplied to 3 current transformers: measuring phase currents.

An additional internal CT directly measures the residual (Zero Sequence) current of the three inputs.

Current inputs can be 1 or 5A: selection between 1A or 5A is made by movable jumpers provided on the Relay card. (see Fig 1)

The Measuring Ranges of the different inputs respectively are:

Phase Currents : (0.1-40)In
 Residual Current : (0.01-10)In

Make electric connection in conformity with the diagram reported on relay's enclosure.

Check that input currents are same as reported on the diagram and on the test certificate.

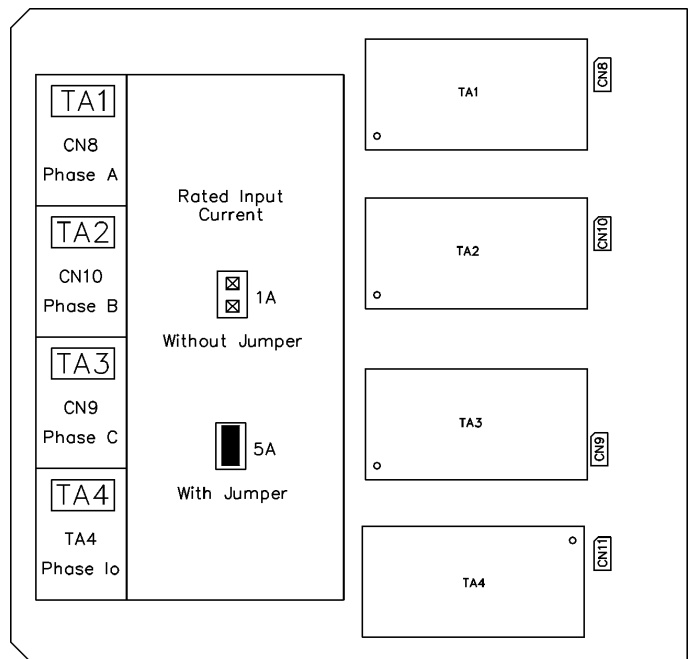

2.1 - Power Supply

The auxiliary power is supplied by a built-in module fully isolated and self protected.

Two options are available:

- a) - { 24V(-20%) / 110V(+15%) a.c.
 { 24V(-20%) / 125V(+20%) d.c.
- b) - { 80V(-20%) / 220V(+15%) a.c.
 { 90V(-20%) / 250V(+20%) d.c.

Before energising the unit check that supply voltage is within the allowed limits.

2.2 - Operation and Algorithms

2.2.1 - Reference Input Values

Display	Description	Setting Range	Step	Unit
I1 100 A	Rated Primary current of phase C.T.	1 - 9999	1	A
I2 5 A	Rated Secondary current of phase C.T.	1 - 5	1/5	A
In 100 A	Reference primary current of the relay	1 - 9999	1	A
Freq 50 Hz	System rated frequency	50 - 60	10	Hz
TW 30 min	Warming-up time constant for Thermal Image	1 - 60	1	min.
Ib 105 %In	Maximum admissible continuous overload for Thermal Image	50 - 130	1	%In

2.2.2 - Input quantities

2.2.2.1 - Mains Frequency (Freq)

The relay can operate either in 50Hz or 60Hz systems.
The rated Mains Frequency " Freq " must be set accordingly.

2.2.2.2 - Phase Current inputs (I1)

The relay directly displays the r.m.s. value of the Phase Currents " IA ", " IB ", " IC " flowing in the Primary of the input Current Transformers and refers all its measurements to that value.
To make the relay properly working with any C.T., when programming the relay settings, input the value "I1" of the primary current of the phase C.Ts

2.2.2.3 - Earth Fault Current Input (Ion)

Same as for the Phase Currents, the relay directly displays the r.m.s. value of the Zero Sequence Residual Current flowing at the Primary of the Current Transformers.

2.2.2.4 - Algorithm of the time current curves

The Time Current Curves are generally calculated with the following equation :

$$(1) \quad t(I) = \left[\frac{A}{\left(\frac{I}{I_s}\right)^{a^a} - 1} + B \right] \bullet K \bullet T_s + t_r$$

where :

$t(I)$ = Actual trip time delay when the input current equals "I"

I = Maximum of the three input currents.

I_s = Set minimum pick-up level

$$K = \left(\frac{A}{10^a - 1} \right)^{-1}$$

T_s = Set time delay : $t(I) = T_s$ when $\frac{I}{I_s} = 10$

t_r = Operation time of the output relay on pick-up (7ms).

The parameters "A" and "a" have different values for the different Time Current Curves.

Curve Name	Curve Identifier	A	B	a
IEC A Inverse	A	0.14	0	0.02
IEC B Very Inverse	B	13.5	0	1
IEC C Extremely Inverse	C	80	0	2
IEEE Moderate Inverse	MI	0.0104	0.0226	0.02
IEEE Short Inverse	SI	0.00342	0.00262	0.02
IEEE Very Inverse	VI	3.88	0.0963	2
IEEE Inverse	I	5.95	0.18	2
IEEE Extremely Inverse	EI	5.67	0.0352	2

The maximum measuring current is "40xIn" for phase elements and "10xOn" for the neutral element.

2.2.3 - Time Current Curves IEC (TU1029 Rev.0)

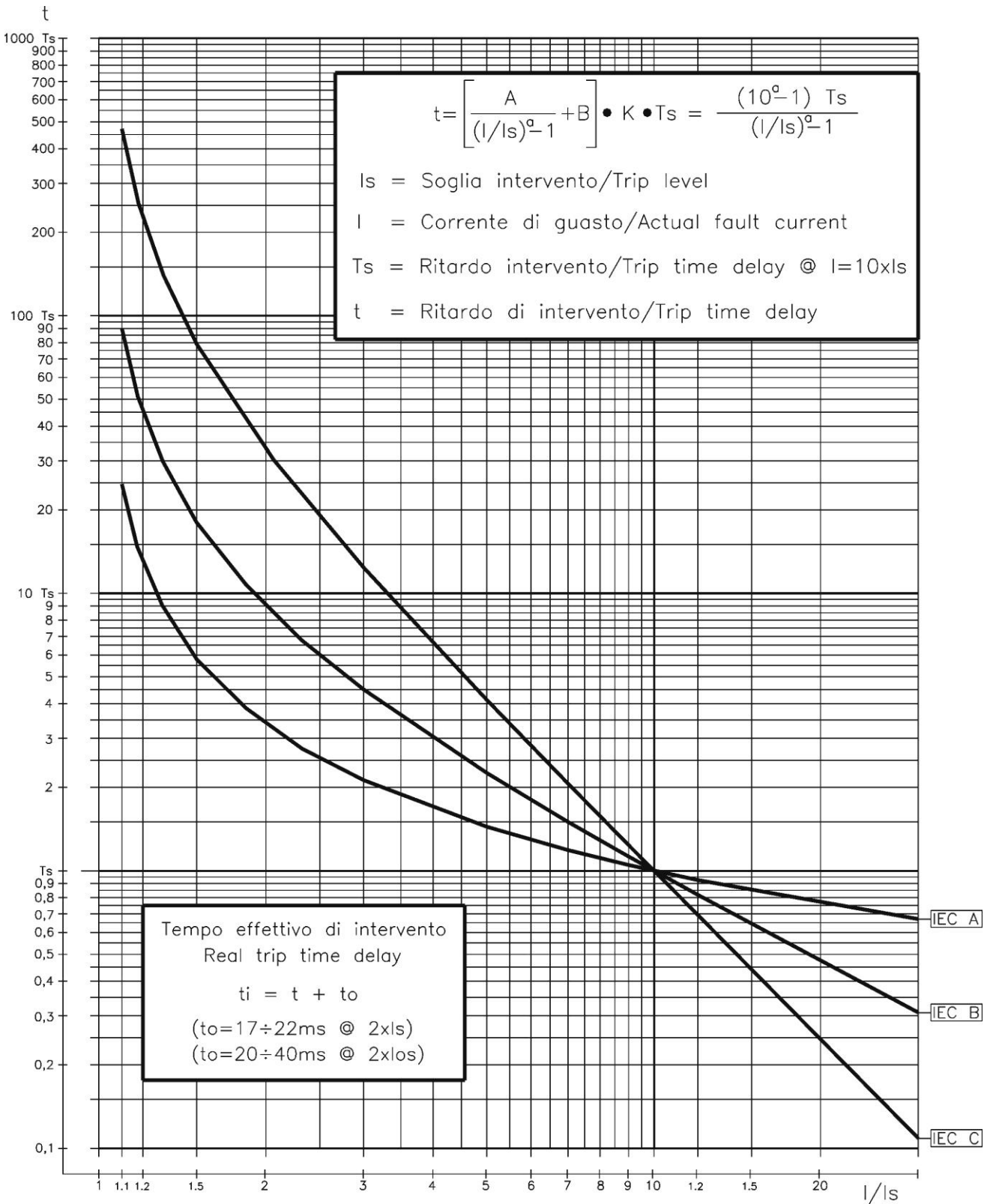

Curve Type	A	B	K	a
IEC A	0.14	0	0.336632	0.02
IEC B	13.5	0	0.666667	1
IEC C	80	0	1.2375	2

Max. "I" Phase = 40xIn
Max. "I" Neutral = 10xIn

2.2.4 - Time Current Curves IEEE (TU1028 Rev.0)

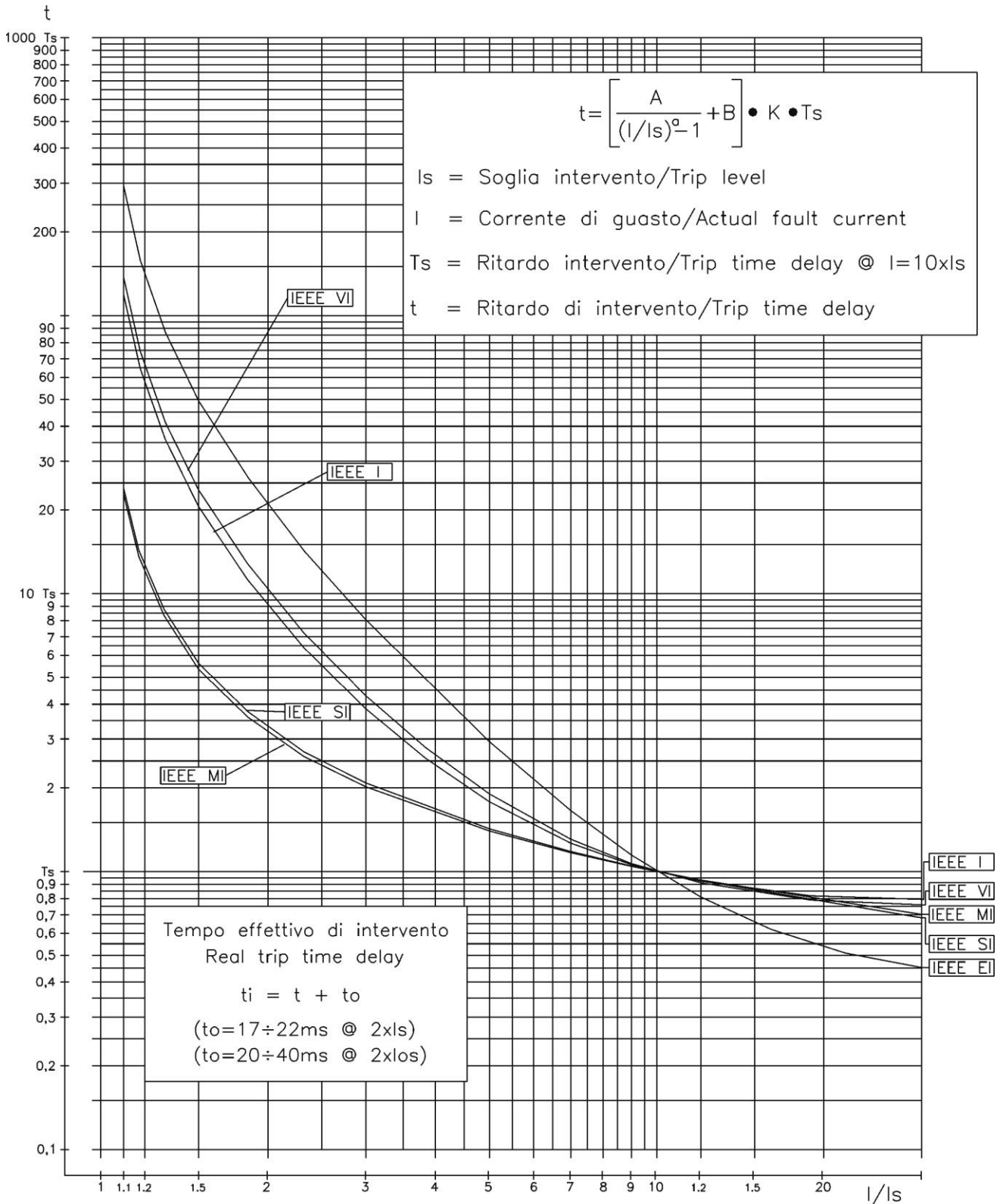

Curve Type	A	B	K	a
MI= IEEE Moderate Inv.	0.0104	0.0226	4.110608	0.02
SI= IEEE Short Inv.	0.00342	0.00262	13.30009	0.02
VI= IEEE Very Inv.	3.88	0.0963	7.380514	2
I= IEEE Inverse	5.95	0.18	4.164914	2
EI= IEEE Extremely Inv.	5.67	0.0352	10.814	2

Max. "I" Phase = 40xIn
 Max. "I" Neutral = 10xOn

2.2.5 - Functions and Settings (Function)

2.2.5.1 - T> (F49) - Thermal Image protection level

FuncEnab	→	Enable		[Disable / Enable]
Options	→	No Param		No Parameters
TripLev	→	Tal 50.00	%Tb	(50.00 ÷ 110.00) step 1 %Tb
	→	Tst 100.00	%Tb	(10.00 ÷ 100.00) step 1 %Tb
Timers	→	No Param		No Parameters

- FuncEnab** : If disable the function is deactivated.
- Tal** : Thermal prealarm temperature.
- Tst** : Reset level.

Warming-up is computed proportionally to the square of the largest phase current “I”.

- Allowed overloading time (See Curve)

The trip time delay “t” of the thermal element, depends on the warming-up time constant “tw”, on the previous thermal status $(I_p/I_n)^2$, on the admissible continuous overload (Ib) and, of course, on the actual load (I)

$$t = tw \cdot \ell_n \left[\frac{(I/I_n)^2 - (I_p/I_n)^2}{(I/I_n)^2 - (I_b/I_n)^2} \right] \quad \text{where :}$$

- tw** = Warming-up time constant (1-60)min.
- I** = Largest of the three phase currents
- I_p** = Preheating current: Steady-State Current corresponding to the thermal status existing at the moment when the current is increased to the overload value “I”
- I_b** = Continuously admissible current (50-130)%I_n, step 1%I_n
- I_n** = Rated primary current of phase C.Ts
- ℓ_n** = Natural logarithm

Reset takes place when the simulated temperature drops below the programming level [Tst].

An alarm signal is issued when the computed warming exceeds the set percentage “Tal” of the Full Load temperature “Tb”.

2.2.5.2 - Thermal Image Curves (TU0445 Rev.0)

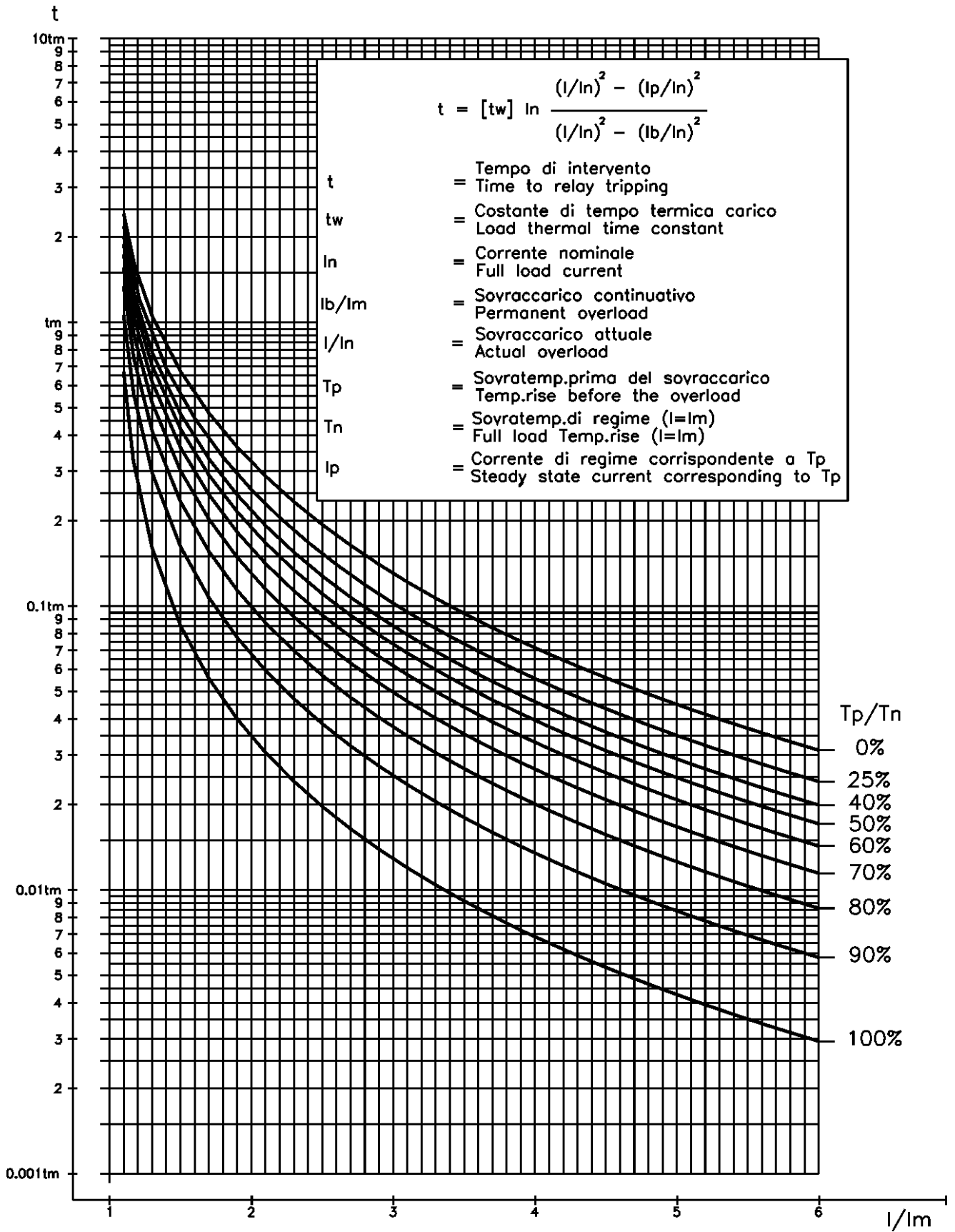

2.2.5.3 - I> (1F51) - First overcurrent protection level

FuncEnab	→	Enable		[Disable / Enable]
Options	→	TCC	D	[D / A / B / C / MI / VI / I / EI // SI]
	→	BI	Disable	[Disable / Enable]
	→	Trg	Enable	[Disable / Enable]
TripLev	→	I>	0.5	In (0.20 ÷ 4.00) step 0.01 In
Timers	→	tI>	2.00	s (0.05 ÷ 60.00) step 0.01 s

- FuncEnab** : If disable the function is deactivated

- TCC** : Time current curves
 - D** = Independent Definite Time
 - A** = IEC A Inverse
 - B** = IEC B Very Inverse
 - C** = IEC C Extremely Inverse
 - MI** = IEEE Moderate Inverse Curve
 - VI** = IEEE Very Inverse Curve
 - I** = IEEE Inverse Curve
 - EI** = IEEE Extremely Inverse Curve
 - SI** = IEEE Short Inverse Curve
- BI** : Operation controlled by Blocking Digital Input
- Trg** : Function operation triggers the oscillographic wave form capture (see § 2.2.3.12)

- I>** : Minimum phase current pick-up level (limited to 40 times In)

- tI>** : Trip time delay

2.2.5.4 - I>> (2F51) - Second overcurrent protection level

FuncEnab	→	Enable		[Disable / Enable]
Options	→	BI	Disable	[Disable / Enable]
	→	2xI	Disable	[Disable / Enable]
	→	Trg	Enable	[Disable / Enable]
TripLev	→	I>>	2.00	In (0.50 ÷ 40.00) step 0.01 In
Timers	→	tI>>	0.10	s (0.05 ÷ 60.00) step 0.01 s
	→	t2xI	1.00	s (0.02 ÷ 9.99) step 0.01 s

- FuncEnab** : If disable the function is deactivated

- BI** : Operation controlled by Blocking Digital Input
- 2xI** : Automatic threshold doubling on inrush
- Trg** : Function operation triggers the oscillographic wave form capture (see § 2.2.3.12)

- I>>** : Minimum phase current pick-up level (limited to 40 times In)

- tI>>** : Trip time delay
- t2xI** : Trip time delay

2.2.5.5 - **IH (3F51)** - Third overcurrent protection level

FuncEnab	→	Enable		[Disable / Enable]
Options	→	BI	Disable	[Disable / Enable]
	→	2xl	Enable	[Disable / Enable]
	→	Trg	Enable	[Disable / Enable]
TripLev	→	IH	5.00	In (0.50 ÷ 40.00) step 0.01 In
Timers	→	tIH	0.10	s (0.05 ÷ 60.00) step 0.01 s
	→	t2xl	0.05	s (0.02 ÷ 9.99) step 0.01 s

- ❑ **FuncEnab** : If disable the function is deactivated

- ❑ **BI** : Operation controlled by Blocking Digital Input
- ❑ **2xl** : Automatic threshold doubling on inrush
- ❑ **Trg** : Function operation triggers the oscillographic wave form capture (see § 2.2.3.12)

- ❑ **IH** : Minimum phase current pick-up level (limited to 40 times In)

- ❑ **t2xl** : Trip time delay
- ❑ **tIH** : Trip time delay

2.2.5.5.1 – Automatic doubling or Overcurrent thresholds on current inrush

For some of the phase Overcurrent functions it is possible to have the set trip level [Is] automatically doubled when strong inrush current is detected.

If at circuit Breaker switch-on (i.e. when the input current rises from zero to a minimum measurable value) the current increases from 0 to 1.5 times the rated value [In] in less than 60ms, the set minimum pick-up level [Is] is dynamically doubled ([Is]→[2Is]) and keeps this value until the input current drops below 1.25xIn or the set time [t2xl] has elapsed.

This functionality is very useful to avoid spurious tripping of the instantaneous or short-time delayed Overcurrent elements that could be experienced at switch-on of reactive loads like Transformer or Capacitors.

2.2.5.6 - **Io>** (1F51N) - First Earth Fault protection level

FuncEnab	→	Enable	[Disable / Enable]
Options	→	TCC D	[D / A / B / C / I / VI / EI / MI / SI]
	→	BI Disable	[Disable / Enable]
	→	Trg Enable	[Disable / Enable]
TripLev	→	Io> 0.10	Ion (0.01 ÷ 4.00) step 0.01 Ion
Timers	→	tIo> 2.00	s (0.05 ÷ 60.00) step 0.01 s

- FuncEnab** : If disable the function is deactivated

- TCC** : Time current curves
 - D** = Independent Definite Time
 - A** = IEC A Inverse
 - B** = IEC B Very Inverse
 - C** = IEC C Extremely Inverse
 - MI** = IEEE Moderate Inverse Curve
 - VI** = IEEE Very Inverse Curve
 - I** = IEEE Inverse Curve
 - EI** = IEEE Extremely Inverse Curve
 - SI** = IEEE Short Inverse Curve
- BI** : Operation controlled by Blocking Digital Input
- Trg** : Function operation triggers the oscillographic wave form capture (see § 2.2.3.12)

- Io>** : Minimum Zero Sequence Residual Current Pick-up level

- tIo>** : Trip time delay

2.2.5.7 - **Io>>** (2F51N) - Second Earth Fault protection level

FuncEnab	→	Enable	[Disable / Enable]
Options	→	BI Disable	[Disable / Enable]
	→	Trg Enable	[Disable / Enable]
TripLev	→	Io>> 0.50	Ion (0.01 ÷ 9.99) step 0.01 Ion
Timers	→	tIo>> 1.00	s (0.05 ÷ 60.00) step 0.01 s

- FuncEnab** : If disable the function is deactivated

- BI** : Operation controlled by Blocking Digital Input
- Trg** : Function operation triggers the oscillographic wave form capture (see § 2.2.3.12)

- Io>>** : Minimum Zero Sequence Residual Current Pick-up level

- tIo>>** : Trip time delay

2.2.5.8 - **IoH (3F51N)** - Third Earth Fault protection level

FuncEnab	→	Enable	[Disable / Enable]
Options	→	BI Disable	[Disable / Enable]
	→	Trg Enable	[Disable / Enable]
TripLev	→	IoH 2.00	Ion (0.01 ÷ 9.99) step 0.01 Ion
Timers	→	tIoH 0.10	s (0.05 ÷ 60.00) step 0.01 s

- FuncEnab** : If disable the function is deactivated
- BI** : Operation controlled by Blocking Digital Input
- Trg** : Function operation triggers the oscillographic wave form capture (see § 2.2.3.12)
- IoH** : Minimum Zero Sequence Residual Current Pick-up level
- tIoH** : Trip time delay

2.2.5.9 - **BF (F51BF)** - Breaker Failure

FuncEnab	→	Enable	[Disable / Enable]
Options	→	TrR Relay1	Relay1 – Relay2 – Relay3 – Relay4
TripLev	→	No Param	No Parameters
Timers	→	tBF 0.20	s (0.05 ÷ 0.75) step 0.01 s

- FuncEnab** : If disable the function is deactivated
- TrR** : Output relay programmed for trip command to the Circuit Breaker
- tBF** : Trip time delay
- Operation:** If after the time “tBF” from pick-up of the programmed relay “TrR” the current measured still exceeds 5%In, the output relay associated to the “BF” function is operated (relay another than TrR).

2.2.5.10 - **RTD** - Remote Trip

Remote trip is controlled via the Digital Input D2.

FuncEnab	→	Disable	[Disable / Enable]
Options	→	No Param	No Parameters
TripLev	→	No Param	No Parameters
Timers	→	No Param	No Parameters

- FuncEnab** : If disable the function is deactivated

2.2.5.11 - **I.R.F.** - Internal Relay Failure

FuncEnab	→	No Param	No Parameters
Options	→	Opl NoTrip	[NoTrip / Trip]
TripLev	→	No Param	No Parameters
Timers	→	No Param	No Parameters

- Opl** : The variable “Opl” can be programmed to trip the output relays same as the other protection functions (Opl = TRIP), or to only operate the “IRF” signal led without tripping the output relays (Opl = NoTRIP).

2.2.5.12 - **Osc** - Oscillographic Recording

FuncEnab	→	Enable	[Disable / Enable]
Options	→	Trg Trip	[Disable / Start / Trip / Ext.Inp.]
TripLev	→	No Param	No Parameters
Timers	→	tPre 0.30	s (0.10 ÷ 0.50) step 0.1 s
	→	tPost 0.30	s (0.10 ÷ 1.50) step 0.1 s

- FuncEnab** : If disable the function is deactivated
- Trg** : *Disab* = Function Disable (no recording)
Start. = Trigger on time start of protection functions
Trip = Trigger on trip (time delay end) of protection functions
Ext.Inp. = Trigger from the Digital Input D3
- tPre** : Recording time before Trigger
- tPost** : Recording time after Trigger

When the option “Start” or “Trip” is selected:

The oscillographic recording is started respectively by the “Time Start” or by the “Time End” of any of the functions that have been programmed to Trigger the Wave Form Capture (I>, I>>, IH, Io>, Io>>, IoH).

The “Osc” Function includes the wave Form Capture of the input quantities (IA, IB, IC, Io) and can totally store a record of 3 seconds.

The number of events recorded depends on the duration of each individual recording (tPre + tPost). In any case the number of event stored can not exceed ten (10 x 0.3 sec). Any new event beyond the 3 sec capacity of the memory, cancel and overwrites the former records (FIFO Memory).

2.2.5.13 - Comm – Communication Parameters

FuncEnab	→	No Param	No Parameters
Options	→	Com Lbd 9600	[9600 / 19200 / 38400]
	→	Com Rbd 9600	[9600 / 19200]
	→	Com Rmd 8,n,1	[8,n,1 / 8,o,1 / 8,e,1]
	→	Com Rpr Modbus	[Iec103 / Modbus]
TripLev	→	No Param	No Parameters
Timers	→	No Param	No Parameters

- Com Lbd** : Local Baud Rate (Front panel RS232 communication speed)
- Com Rbd** : Remote Baud Rate
(Rear panel terminal blocks RS485 communication speed)
- Com Rmd** : Remote mode (communication parameters)
Note: Any change of this setting becomes valid at the next power on
- Com Rpr** : Remote Protocol

2.2.5.14 - LCD – Display and Buzzer operation

FuncEnab	→	No Param	No Parameters
Options	→	Key BeepON	[BeepOFF / BeepON]
	→	LCD Auto	[Auto / On]
TripLev	→	No Param	No Parameters
Timers	→	No Param	No Parameters

- Key** : Buzzer “Beep” on operation of Keyboard buttons.
- LCD** : LCD Backlight continuously “ON” or switched-on Automatically on operation of Keyboard buttons.

3. LOGIC BLOCKING OF FUNCTIONS

3.1 - Blocking Outputs

The instantaneous element of each of the protection functions (1F50, 2F50, 3F50, 1F50N, 2F50N, 3F50N) can be programmed to control one of the Output Relays.

This relay picks-up as soon as the input quantity exceeds the set trip level of the Protection Function and it automatically resets when the input quantity drops below the function reset level ($\approx 95\%$ of the trip level) or, in any case as soon as the time delay (tBF) of the Breaker Failure function is expired.

This instantaneous output can be used to activate the Blocking Input of another Protection Relay to implement a logic selectivity systems. As above explained, in case of Breaker Failure, the blocking output is released and the back-up protection enabled.

3.2 – Blocking Inputs

The time delayed tripping of any of the Protection functions (1F51, 2F51, 3F51, 1F51N, 2F51N, 3F51N) can be controlled by the activation of the Digital Input D1 (BI=Enable): in this case the set trip time delay of the function is increased by “2xtBF” so that other Protection Relays (set with the same trip time delay) that send the activation signal to the blocking Input D2, can trip before open and the C/B nearest to the Fault.

Also in this case, however, another “2xtBF” seconds from the expiry of the set trip time delay, the blocking input is disregarded so allowing the protection relay to trip in case of Failure to open of the upstream Circuit Breaker.

4. OUTPUT RELAYS

Four user programmable Output Relays are normally available R1, R2, R3, R4.

Each of them can be programmed to be controlled by any element (instantaneous or time delayed) of any of the Relay Functions including Breaker Failure and Internal Relay Fault.

Each output relay can also be programmed to operate “OPEN” and “CLOSE” control of the C/B either by the Relay Keyboard or via the serial communication bus

Moreover, the operation of each of the output relays can be programmed to be either Normally Deenergized (energized on tripping of the controlling Functional Element) or Normally Energized (Deenergized on tripping of the controlling Functional Element) (see § 12.7).

As an option (to be required when ordering the relay), the output relay “R4” can be replaced by a Field Bus output (CANBUS) that controls additional I/O modules for increasing as needed the number of user programmable Output Relays and Digital Inputs controlled from the MC30 relay.

5. DIGITAL INPUTS

Three optoisolated, selfpowered Digital Inputs D1, D2, D3 are provided.
A Digital Input is activated when its terminals are shorted by a cold contact.

- | | | |
|------------------------------------|---------------------|---|
| <input type="checkbox"/> D1 | (terminals 22 - 19) | : It is usable as Function Blocking Input |
| <input type="checkbox"/> D2 | (terminals 22 - 21) | : It is used for Remote Trip |
| <input type="checkbox"/> D3 | (terminals 22 - 20) | : The digital Input indicates the position of the Circuit Breaker (Input Closed = C/B closed; Input Open = C/B open).
If the option External Trigger = Enabled any time the DI passed from closed to open the oscillographic recording is started. |

6. SELFDIAGNOSTIC

The MC30 incorporates a sophisticated selfdiagnostic feature that continuously checks the following elements:

- A/D conversion
- Checksum of the settings stored into E²Prom.
- DSP general operation (Power, Routines, etc.)
- Lamp test (only on manual test).

Any time Power is switched on, a complete test is run; then, during normal operation, the test runs continuously and the checksum is done any time a parameter is stored into E²Prom.

If during the test any Relay Internal Failure (I.R.F) is detected:

If " I.R.F. " is programmed to " Trip ", the programmed output relays are operated same as on tripping of any protection function operation is stored in the " Event Records " and the I.R.F. signal led is set to flashing.

If " I.R.F. " is programmed to "NO Trip", and only the I.R.F. signal led is set to flashing.

7. RELAY MANAGEMENT

The relay can be totally managed locally, either by the RS232 communication port or by the 4 key buttons and the LCD display, or remotely via the communication bus RS485 connected to the rear terminal blocks. The 2 line x 8 characters LCD display shows the available information. Key buttons operate according to the flow-chart herebelow.

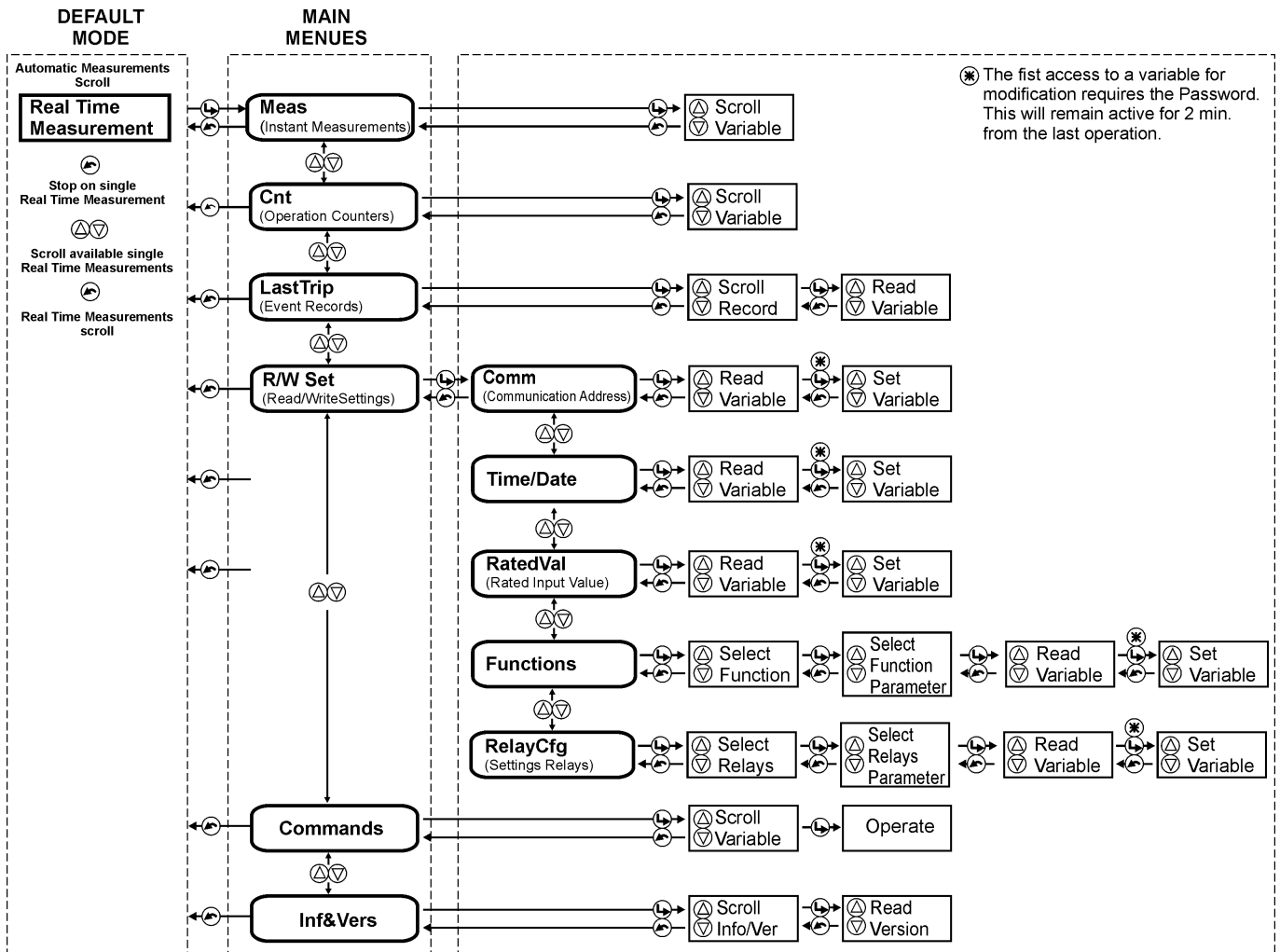
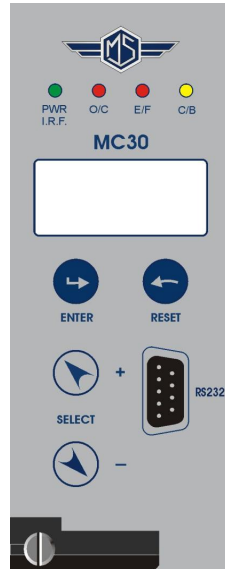

8. SIGNALIZATIONS

Four signal leds are available on the Front Face Panel:

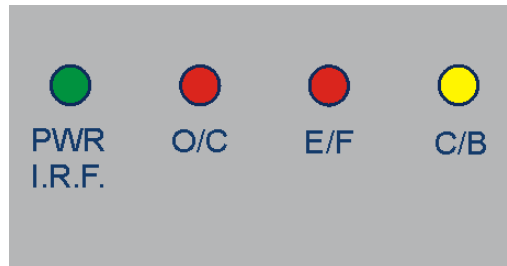

a)	Green LED	PWR I.R.F.	<input type="checkbox"/> Illuminated during normal operation when Power Supply is ON. <input type="checkbox"/> Flashing when a Relay Internal Fault is detected.
b)	Red LED	O/C (*)	<input type="checkbox"/> Flashing when a timed phase O/C element start to operate. <input type="checkbox"/> Illuminated when any time delayed O/C element is tripped; reset takes place by pressing the reset button.
c)	Red LED	E/F (*)	<input type="checkbox"/> Flashing when a timed phase E/F element start to operate. <input type="checkbox"/> Illuminated when any time delayed E/F element is tripped; reset takes place by pressing the reset button.
a)	Green Yellow	C/B	<input type="checkbox"/> Illuminated when C/B closed (Digital Input D3 shorted). <input type="checkbox"/> Off when C/B open (Digital Input D3 open). <input type="checkbox"/> Flashing when BF function is tripped.

(*) When any protection function is tripped the display shows the function that caused the tripping:

LastTrip	steady
"Cause"	blinking

9. KEYBOARD BUTTONS

	Enter	Give access to any menu or convalidate any programming changement.
	Reset	Return from the actual selected menu to the former menu.
	Select +	Scrolls variables available in the different menus or increases/decreases setting values.
	Select -	

10. Serial Communication Port

10.1 . Main RS485 Serial Communication Port

This port is accessible via the terminals 1-2-3 provided on the relay terminal board.
 It is used for connection to a serial bus interfacing up to 31 units with the Central Supervision System (SCADA, DCS, ecc).
 The serial bus is a shielded pair of twisted cables connecting in parallel (Multi Drop) the different units (slaves) by the relevant terminals.
 The physical link is RS485 and the Communication Protocol is MODBUS/RTU / IEC60870-5-103.
 The configuration of transmission parameters is selectable.

<input type="checkbox"/>	Baud Rate	: 9600/19200 bps	9600/19200 bps	9600/19200 bps
<input type="checkbox"/>	Start bit	: 1	1	1
<input type="checkbox"/>	Data bit	: 8	8	8
<input type="checkbox"/>	Parity	: None	Odd	Even
<input type="checkbox"/>	Stop bit	: 1	1	1

Note: any change of this setting becomes valid at the next power on.

Each relay is identified by its programmable address code (NodeAd) and can be called from the P.C.
 A dedicated communication software (MSCom) for windows 95/98/NT4 SP3 (or later) is available.
 Please refer to the MSCom instruction manual for more information.
 Maximum length of the serial bus can be up to 200m.

CONNECTION TO RS485

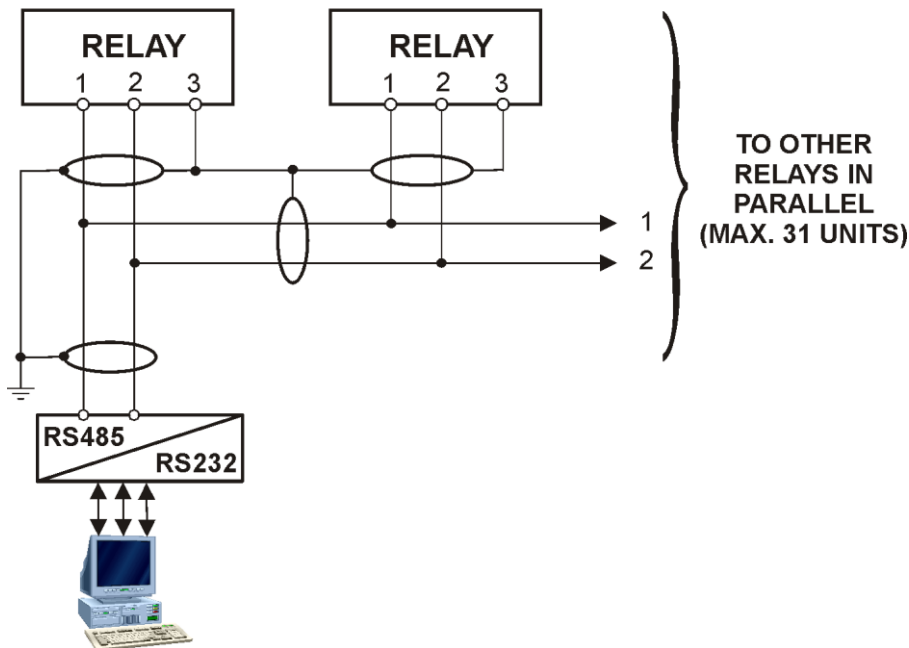

For longer distance and for connection of up to 250 Relays, optical interconnection is recommend.
 (please ask Microelettrica for accessories)

10.2 - Communication Port on Front Face Panel

This port is used for communication through the Front Face Panel between a local Lap-top PC.

The physical link is RS232 by the standard female 9-pin D-sub connector available on the Front Face Panel. Via this Port complete Relay management and data acquisition is possible.

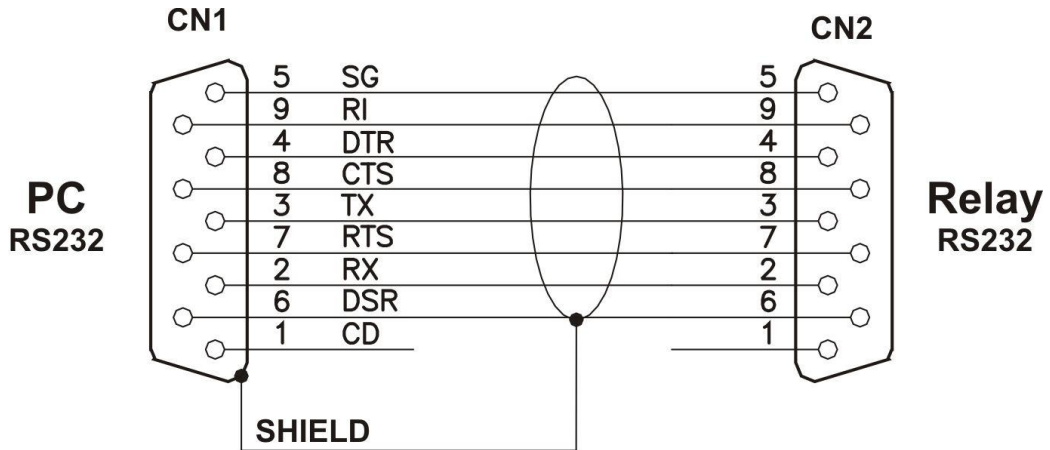



11. MENU AND VARIABLES

11.1 - Real Time Measurements

Scrolling display of the Real Time Measurements is the Default operation.





Scrolling can be stopped at any of the measurements and restarted by pressing the Reset button .

When stopped on one variable,  appears aside the measurement and the different available measurements can be selected by the   buttons.

Display			Description
I	= 0 – 65535	%In	Largest of the 3 phase-currents (% of rated current)
IA	= 0 – 65535	A	RMS value of Phase A current
IB	= 0 – 65535	A	RMS value of Phase B current
IC	= 0 – 65535	A	RMS value of Phase C current
Io	= 0.0 – 6553.5	A	RMS value of Zero Sequence Current (RMS Primary Amps)
Tem	= 0 - 65535	%T	Actual temperature rise

11.2 - Meas (Instantaneous Measurements)





Real time measurements can be frozen at any moment selecting the menu “ Instant Measure “:

- “ Real Time Meas “ 
- “ Meas “ 
- “ 1st Measurement   other measurements
-  to go back to “ Meas “

Display			Description
I	= 0 – 65535	%In	Largest of the 3 phase-currents (% of rated current)
IA	= 0 – 65535	A	RMS value of Phase A current (Primary Amps)
IB	= 0 – 65535	A	RMS value of Phase B current (Primary Amps)
IC	= 0 – 65535	A	RMS value of Phase C current (Primary Amps)
Io	= 0.0 – 6553.5	A	RMS value of Zero Sequence Current (Primary Amps)
Tem	= 0 - 65535	%T	Actual temperature rise

11.3 - Counter (Operation Counters)

The operation of any of the function herebelow reported, is counted and recorded in the menu “Counters “.







- “ Real Time Meas “ 
- “Counter “ 
- “ 1st counters   other counters
-  to go back to “Counter “

Display			Description
I>	=	0 – 65535	Number of 1 st Overcurrent (time delayed) trip
I>>	=	0 – 65535	Number of 2 nd Overcurrent (time delayed) trip
IH	=	0 – 65535	Number of 3 rd Overcurrent (time delayed) trip
Io>	=	0 – 65535	Number of 1 st time delayed Earth Fault trip
Io>>	=	0 – 65535	Number of 2 nd time delayed Earth Fault trip
IoH	=	0 – 65535	Number of 3 rd time delayed Earth Fault trip
BF	=	0 – 65535	Number of operation of Breaker Failure
RTD	=	0 – 65535	Number of External Trip commands
I.R.F.	=	0 – 65535	Number of Internal Relay Faults
HR	=	0 – 65535	Number of HW recovery operations



11.4 - LastTrip (Event Recording)

The MC records any tripping and stores the information relevant to the last five tripping of protection functions (FIFO).

Each event recording includes the following information.

- " Real Time Meas " 
- " LastTrip " 
-  1st event,
-  to scroll available events,
-  to " Rec # " selected,
-  to select the different fields;

Display		Description
Func	xxxxx	Indication of the protection function which caused the relay tripping. For indication of the TRIP Cause the following acronyms are used:
		<ul style="list-style-type: none"> - T> = Thermal Image - I> = 1st Overcurrent (Short Circuit) - I>> = 2nd Overcurrent (Short Circuit) - IH = 3rd Overcurrent (Short Circuit) - Io> = 1st Earth Fault - Io>> = 2nd Earth Fault - IoH = 3rd Earth Fault - RTD = External Trip commands - IRF = Internal Relay Fault
Date	: YYYY/MM/GG	Date: Year/Month/Day
Time	: hh:mm:ss:cc	Time: hours/minutes/second/hundredths of seconds
IA	= 0 – 65535 A	RMS value of phase A current (Primary Amps)
IB	= 0 – 65535 A	RMS value of phase B current (Primary Amps)
IC	= 0 – 65535 A	RMS value of phase C current (Primary Amps)
Io	= 0.0 – 6553.5 A	RMS value of Zero Sequence Current (Primary Amps)
Tem	= 0 - 65535 %T	Actual temperature rise

-  to go back to " Rec # ",
-  to go back to " Real Time Meas ".

11.5 - R/W Set (Programming / Reading the Relay Settings)

- “ Main Menu “
- select “ Function “
- select among following sub menus:

11.5.1 - CommAdd (Communication Address)

- “ Commun “
- “ Add: # “
- “ Password ???? “ (if not yet entered; see § Password)
- to select the Address (1-250)
- to validate. Set Done!

The default address is 1.

Display	Description	Setting Range	Step	Unit
Add: 1	Identification number for connection on serial communication bus	1 - 250	1	-

11.5.2 - Time/Date (Time/Date)

- “ Time/Date “ Date: Current Date, Time: Current time
- “ YY/..... “ to set year,
- “ XX/MM “ to set month,
- “ XX/XX/DD “ to set day,
- “ XX/XX/XX “
- “ hh/mm “ to set hour,
- “ XX/mm “ to set minutes,
- To validate Set Done!
- Exit

11.5.3 - RatedVal (Rated Input Values)

- “RatedVal “
- 1st Variable
- to scroll variables
- to modify selected variable
- “ Password ???? “ (if not yet entered) or #??? (if not yet entered; see § Password)
- to set variable value,
- to validate. Set Done!

Display	Description	Setting Range	Step	Unit
I1 100 A	Rated Primary current of phase C.T.	1 - 9999	1	A
I2 5 A	Rated Secondary current of phase C.T.	1 - 5	1/5	A
In 100 A	Reference primary current of the relay	1 - 9999	1	A
Freq 50 Hz	System rated frequency	50 - 60	10	Hz
TW 30 min	Warming-up time constant for Thermal Image	1 - 60	1	min.
Ib 105 %In	Maximum admissible continuous overload for Thermal Image	50 - 130	1	%In

11.5.4 - Function (Functions)

- “ Function “,
 - 1st function,
 - to scroll available Functions,
 - to Read/Write setting of the selected function,
 - to select the different definable fields
 - to access the selected field and read the actual setting of the relevant variable
 - to modify the actual setting;
 - to set the new value.
 - to validate.
- FuncEnab - TripLev
- Options - Timers
- Set Done!

Display					Description	Setting Range	Step	
Function	Type	Variable	Default Setting	Unit				
Password = 0000-9999 1111 -					Password for programming enable (see § Password)			
T> (F49)	FuncEnab	→		Disable	Enable of the protection function	Enable/Disable	-	
	Options	→		NoParam	No Parameters	-	-	
	TripLev	→	Tal	50	%Tb	Thermal prealarm	50 - 110	1
			Tst	100	%Tb	Reset level.	10 - 100	1
Timers	→		NoParam	No Parameters	-	-		
I> (1F51)	FuncEnab	→		Disable	Enable of the protection function	Enable/Disable	-	
	Options	→	TCC	D	Time Current Curves	D,A,B,C, I, VI, EI, MI, SI	-	
			BI	Disable	Operation controlled by Blocking Digital Input	Enable/Disable	-	
			Trg	Disable	Function operation triggers the oscillographic wave form capture	Enable/Disable	-	
	TripLev	→	I>	0.20	In	Trip level of overcurrent protection	0.20 – 4.00	0.01
Timers	→	tl>	0.05	s	Trip time delay	0.05 – 60.00	0.01	
I>> (2F51)	FuncEnab	→		Disable	Enable of the protection function	Enable/Disable	-	
	Options	→	BI	Disable	Operation controlled by Blocking Digital Input	Enable/Disable	-	
			2xl	Disable	Automatic threshold doubling on inrush	Enable/Disable	-	
			Trg	Disable	Function operation triggers the oscillographic wave form capture	Enable/Disable	-	
	TripLev	→	I>>	0.50	In	Trip level of overcurrent protection	0.50 – 40.00	0.01
Timers	→	t2xl	0.05	s	Trip time delay Automatic threshold doubling	0.02 – 9.99	0.01	
		tl>>	0.02	s	Trip time delay	0.05 – 60.00	0.01	
IH (3F51)	FuncEnab	→		Disable	Enable of the protection function	Enable/Disable	-	
	Options	→	BI	Disable	Operation controlled by Blocking Digital Input	Enable/Disable	-	
			2xl	Disable	Automatic threshold doubling on inrush	Enable/Disable	-	
			Trg	Disable	Function operation triggers the oscillographic wave form capture	Enable/Disable	-	
	TripLev	→	IH	0.50	In	Trip level of overcurrent protection	0.50 – 40.00	0.01
Timers	→	t2xl	0.02	s	Trip time delay Automatic threshold doubling	0.02 – 9.99	0.01	
		tlH	0.05	s	Trip time delay	0.05 – 60.00	0.01	
Io> (1F51N)	FuncEnab	→		Disable	Enable of the protection function	Enable/Disable	-	
	Options	→	TCC	D	Time Current Curves	D,A,B,C, I, VI, EI, MI, SI	-	
			BI	Disable	Operation controlled by Blocking Digital Input	Enable/Disable	-	
			Trg	Disable	Function operation triggers the oscillographic wave form capture	Enable/Disable	-	
	TripLev	→	Io>	0.01	Ion	Trip level of Earth Fault protection	0.01 – 4.00	0.01
Timers	→	tIo>	0.05	s	Trip time delay	0.05 – 60.00	0.01	
Io>> (2F51N)	FuncEnab	→		Disable	Enable of the protection function	Enable/Disable	-	
	Options	→	BI	Disable	Operation controlled by Blocking Digital Input	Enable/Disable	-	
			Trg	Disable	Function operation triggers the oscillographic wave form capture	Enable/Disable	-	
	TripLev	→	Io>>	0.01	Ion	Trip level of Earth Fault protection	0.01 – 9.99	0.01
Timers	→	tIo>>	0.3	s	Trip time delay	0.05 – 60.00	0.01	

Function	Display				Description	Setting Range	Step	
	Type		Variable	Default Value				Unit
IoH (3F51N)	FuncEnab	→		Disable	Enable of the protection function	Enable/Disable	-	
	Options	→	BI	Disable	Operation controlled by Blocking Digital Input	Enable/Disable	-	
			Trg	Disable	Function operation triggers the oscillographic wave form capture	Enable/Disable	-	
	TripLev	→	IoH	0.01	Ion	Trip level of Earth Fault protection	1.00 – 9.99	0.01
Timers	→	tIoH	0.05	s	Trip time delay	0.05 – 60.00	0.01	
BF (F51BF)	FuncEnab	→		Disable	Enable of the protection function	Enable/Disable	-	
	Options	→	TrR	Relay1	Output relay operated on BF tripping	Relay1- Relay2 Relay3- Relay4	-	
			No Parameters					
	Timers	→	tBF	0.05	s	Time delay for Breaker Failure alarm	0.05 – 0.75	0.01
RTD	FuncEnab	→		Disable	Enable of the protection function	Enable/Disable	-	
	Options	→	No Parameters					
	TripLev	→	No Parameters					
	Timers	→	No Parameters					
IRF	FuncEnab	→		Enable	Enable of the protection function	Enable/Disable	-	
	Options	→	Opl	NoTrip	Operation of output Relays on detection of Internal Relay Fault	NoTrip – Trip	-	
			No Parameters					
	TripLev	→	No Parameters					
Timers	→	No Parameters						
Osc	FuncEnab	→		Disable	Enable of the protection function	Enable/Disable	-	
	Options	→	Trg	Disable	Trigger operation mode	Disable Start Trip Ext.Inp	-	
			No Parameters					
	Timers	→	tPre	0.10		Recording time before Trigger	0.10 – 0.50	0.1
tPost			0.50		Recording time after Trigger	0.10 – 1.50	0.1	
Comm	FuncEnab	→	No Parameters					
	Options	→	Com Lbd	9600		Local Baud Rate (Front panel RS232 communication speed)	9600 - 19200 38400	-
			Com Rbd	9600		Remote Baud Rate (Rear panel terminal blocks RS485 communication speed)	9600 - 19200	-
			Com Rmd	8,N,1		Remote mode (communication parameters) <i>Note: any change of this setting became valid at the next power on</i>	8,N,1 8,O,1 8,E,1	-
			Com Rpr	lec103		Remote Protocol	lec103-Modbus	-
	TripLev	→	No Parameters					
Timers	→	No Parameters						
LCD	FuncEnab	→	No Parameters					
	Options	→	Key	BeepON		Buzzer "Beep" on operation of Keyboard buttons.	BeepON- BeepOFF	-
			BkL	ON		LCD Backlight continuously "ON" or switched-on Automatically on operation of Keyboard buttons.	ON - OFF	-
	TripLev	→	No Parameters					
Timers	→	No Parameters						

Settings can also be programmed via the serial communication ports.

11.6 - RelayCfg (Relay Configuration)

To associate one of the Output Relays to one or more functions (see § 13): enter the menu “R/W Set”, select “Relay Cfg”, select the “Relay #” to be programmed, select “Link”; at this stage the list of the available functions is displayed. Scrolling the list by the “+” and “-” keys the function is selected and then assigned by the key “Enter”. The assignment is confirmed by the function indication that switches from blinking to steady.





Any of the Output Relays can be programmed to work in two different modes:

- **N.D.** Normally Deenergized Relay is energized on trip of the associated functions
- **N.E.** Normally Energized Relay is deenergized on trip of the associated functions

Programming of working mode is made as above selecting “OpMode” instead of “Link”.

Relay	Display		Description	Setting Range	Step
	Type	Default Value			
Relay1 (R1)	Link	→ T>, tl>, l>>, tIH, tlo>, tlo>>, tloH	Association of functions to output relay R1	T> - Ta -l> - tl> - l>> - tl>> - IH - tIH - lo> - tlo> - lo>> - tlo>> - tloH -BF - RTD - IRF - HwRec - CBopen - CBclose	-
	OpMode	→ N.D.	N.D. (Normally Deenergized) N.E. (Normally Energized)	N.D./N.E.	-
Relay2 (R2)	Link	→ BF	Association of functions to output relay R2	T> - Ta -l> - tl> - l>> - tl>> - IH - tIH - lo> - tlo> - lo>> - tlo>> - tloH -BF - RTD - IRF - HwRec - CBopen - CBclose	-
	OpMode	→ N.D.	N.D. (Normally Deenergized) N.E. (Normally Energized)	N.D./N.E.	-
Relay3 (R3)	Link	→ Ta, l>, l>>, IH, lo>, lo>>, loH	Association of functions to output relay R3	T> - Ta -l> - tl> - l>> - tl>> - IH - tIH - lo> - tlo> - lo>> - tlo>> - tloH -BF - RTD - IRF - HwRec - CBopen - CBclose	-
	OpMode	→ N.D.	N.D. (Normally Deenergized) N.E. (Normally Energized)	N.D./N.E.	-
Relay4 (R4)	Link	→ IRF	Association of functions to output relay R4	T> - Ta -l> - tl> - l>> - tl>> - IH - tIH - lo> - tlo> - lo>> - tlo>> - tloH -BF - RTD - IRF - HwRec - CBopen - CBclose	-
	OpMode	→ N.E.	N.D. (Normally Deenergized) N.E. (Normally Energized)	N.D./N.E.	-







11.7 - Commands

-  “ Commands “
-  1st Control,
-  to select other available control,
-  to operate selected control.

Display	Description
Clear	: Erase memory of Trip Counters, Event Records.
Test	: Starts a relay diagnostic test
Reset	: Reset after trip
CBopen	: Manual Open - Close Breaker
CBclose	: Manual Close - Close Breaker

11.8 - Info&Ver (Firmware - Info&Version)

The menu displays the Relay Model and the Firmware Version

- “ Real Time Meas “ 
-  “ Info/Ver “,
-  “ Model XXXXXX ”, Model Relay
-  “ RelayVrs ###.#.#X “, Firmware Version
-  to go back to “ Info&Ver “.
-  to go back to “ Real Time Meas “

12. KEYBOARD OPERATIONAL DIAGRAM

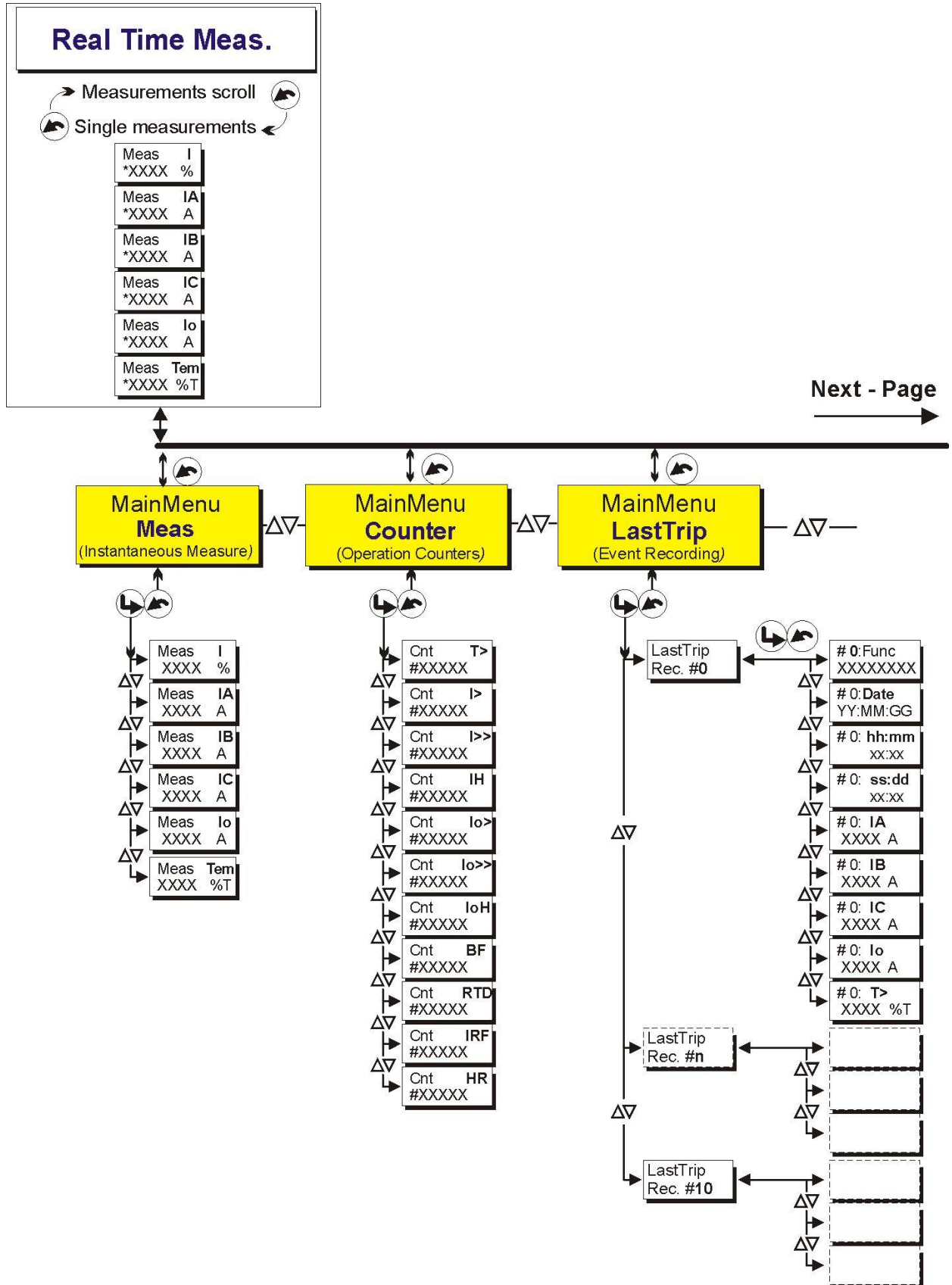

Previous - Page

Next - Page

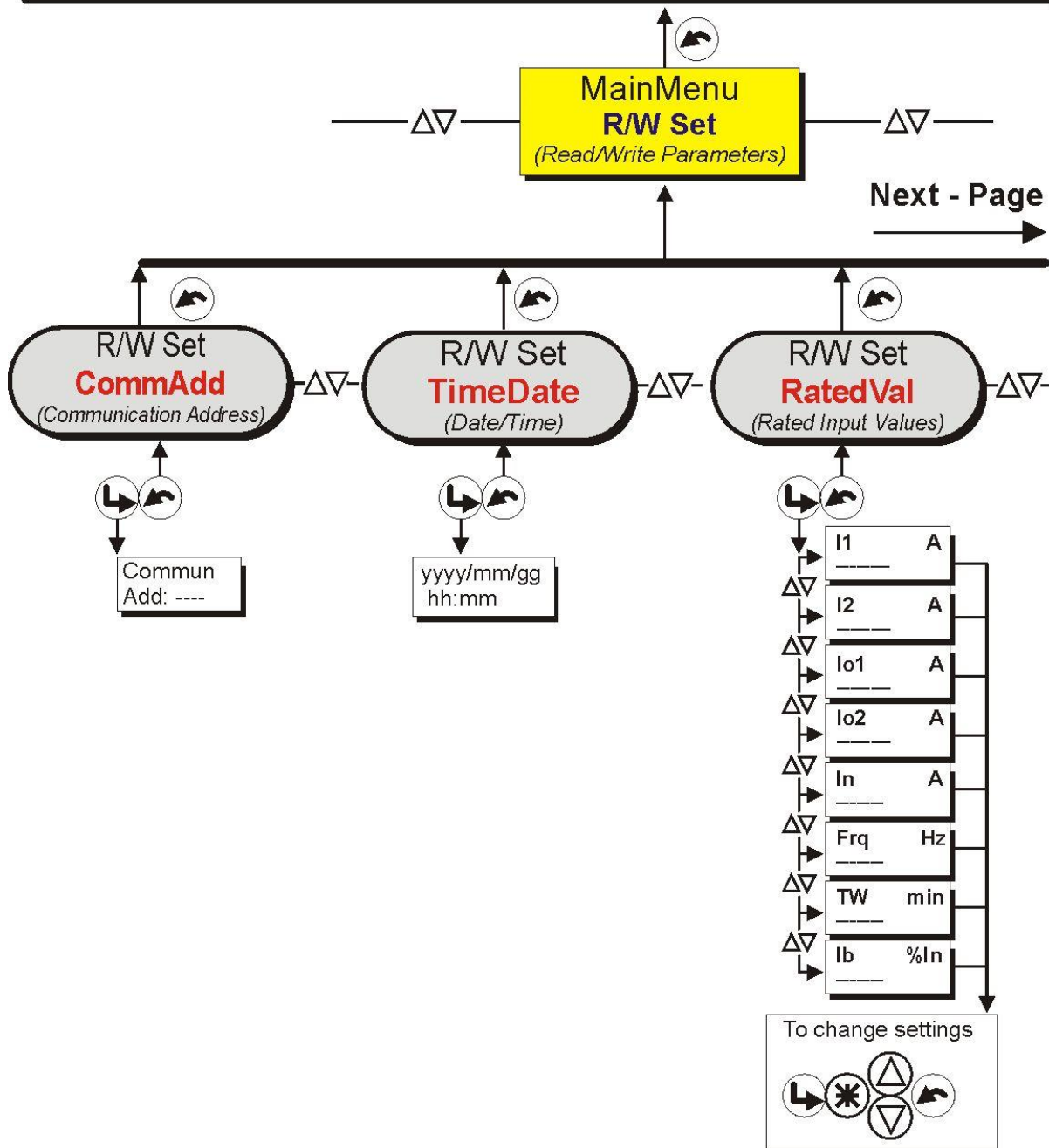

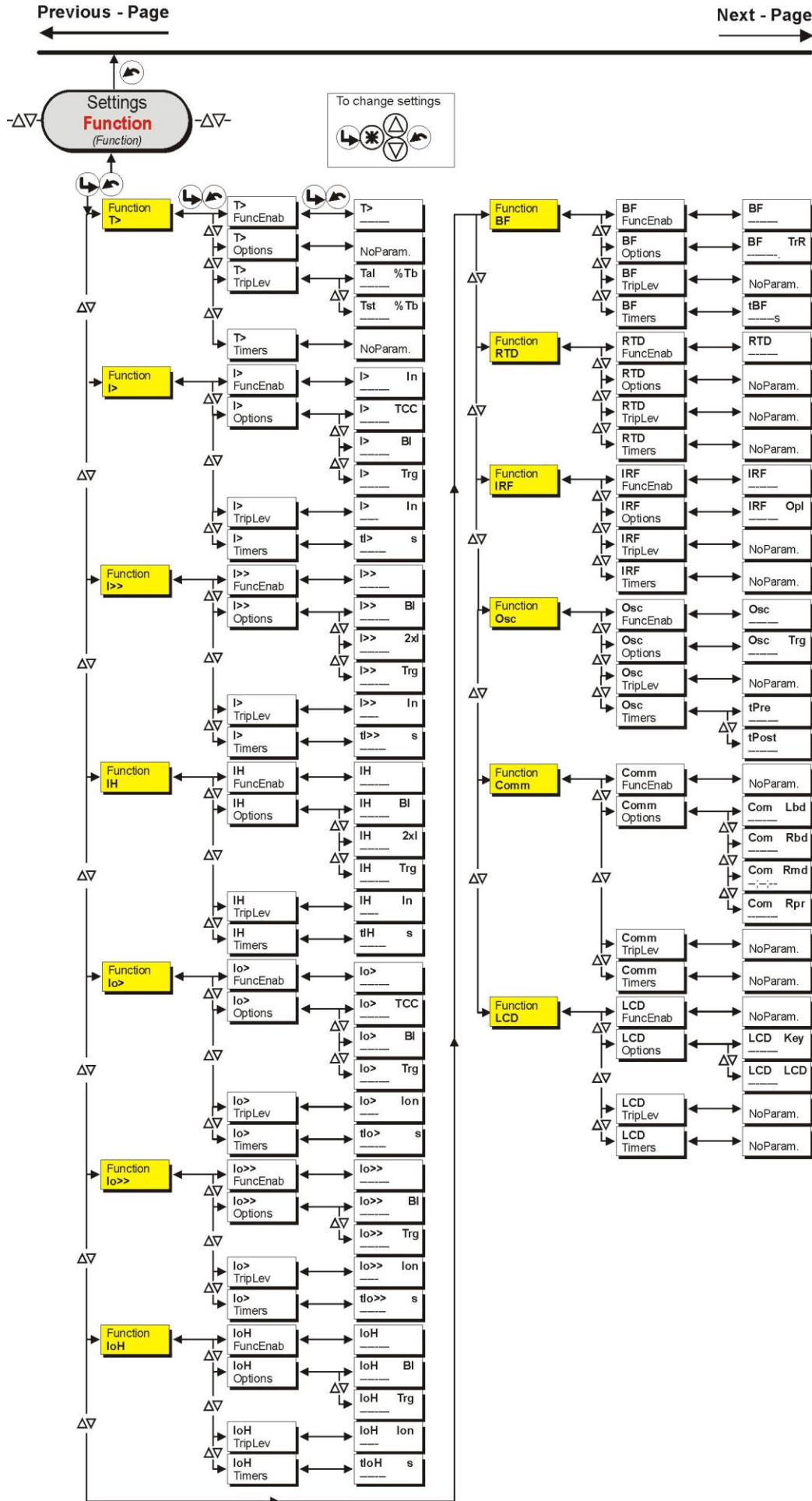

Previous - Page

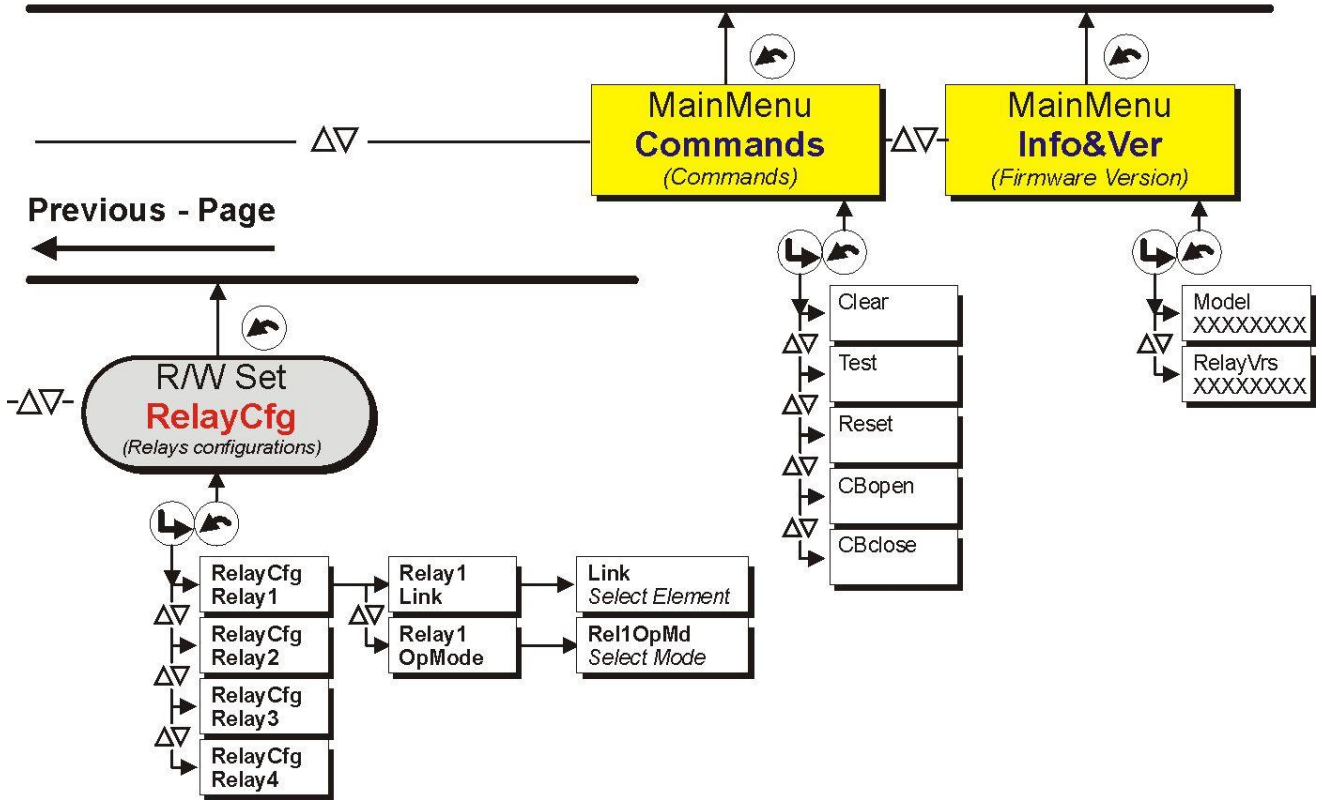

Previous - Page

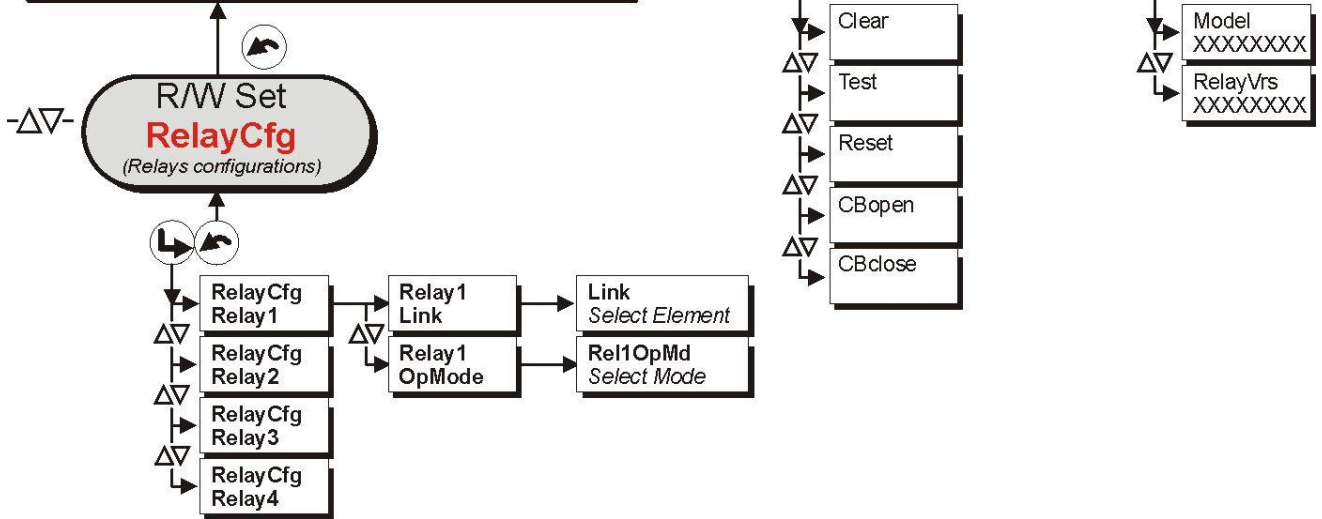









13. PASSWORD

This password is requested anytime the user wants to write in the “Settings” menu a command of the “Commands” menu.

The default password is “ 1111 “

When password is required, proceed as follows

The Display shows the message “ Password ????? “

-  to select 1st digit (1-9)  to validate
-  to select 2nd digit (1-9)  to validate
-  to select 3rd digit (1-9)  to validate
-  to select 4th digit (1-9)  to complete procedure.

The “ password “ is required any time you attempt to modify one of the programmable variables at the first entrance in the “Settings” and/or “Commands” menus.

The “ password “remains valid for 2 minutes from the last operation of the programming buttons or until the  button is pressed to return to the default display (RT Meas).

Once the Password has been entered, a “ # “ appears before the variable that can be modified.

13.1 - MS-Com Password

This password is requested anytime the user wants to send to the relay a setting parameters modification or to issue a command through the relay itself using the managing software MSCom.

The user can decide whether inserting his own password (see MS-Com Operational Manual) or keeping the password disabled just clicking on the OK button when the password is requested.

14. MAINTENANCE

No maintenance is required. In case of malfunctioning please contact Microelettrica Scientifica Service or the local Authorised Dealer mentioning the relay's Serial No reported in the label on relays enclosure.

15. POWER FREQUENCY INSULATION TEST

Every relay individually undergoes a factory insulation test according to IEC255-5 standard at 2 kV, 50 Hz 1min. Insulation test should not be repeated as it unusefully stresses the dielectrics.

When doing the insulation test, the terminals relevant to serial output, digital inputs and RTD input must always be short circuited to ground. When relays are mounted in switchboards or relay boards that have to undergo the insulation tests, the relay should be isolated. This is extremely important as discharges eventually tacking place in other parts or components of the board can severely damage the relays or cause damages not immediately evident to the electronic components.

16. CONNECTION DIAGRAM

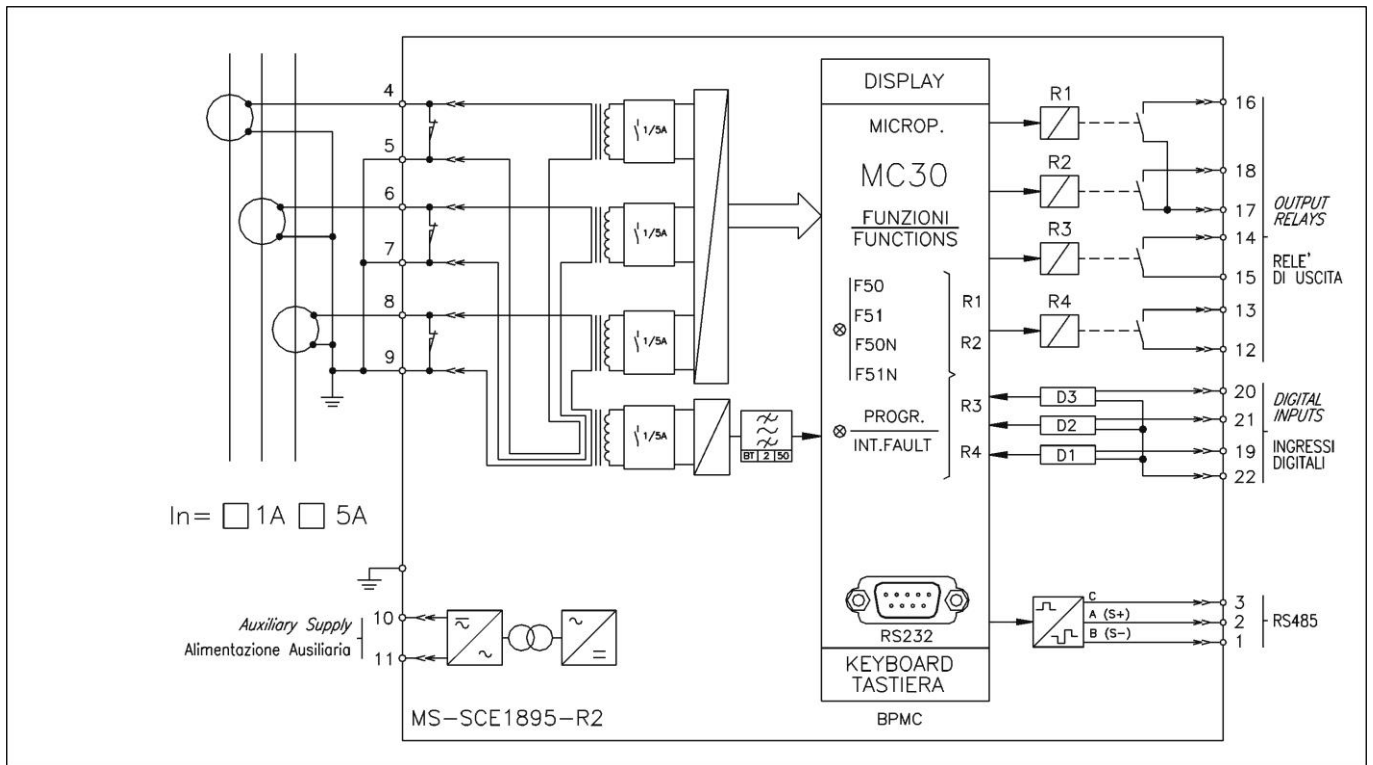

17. OVERALL DIMENSIONS

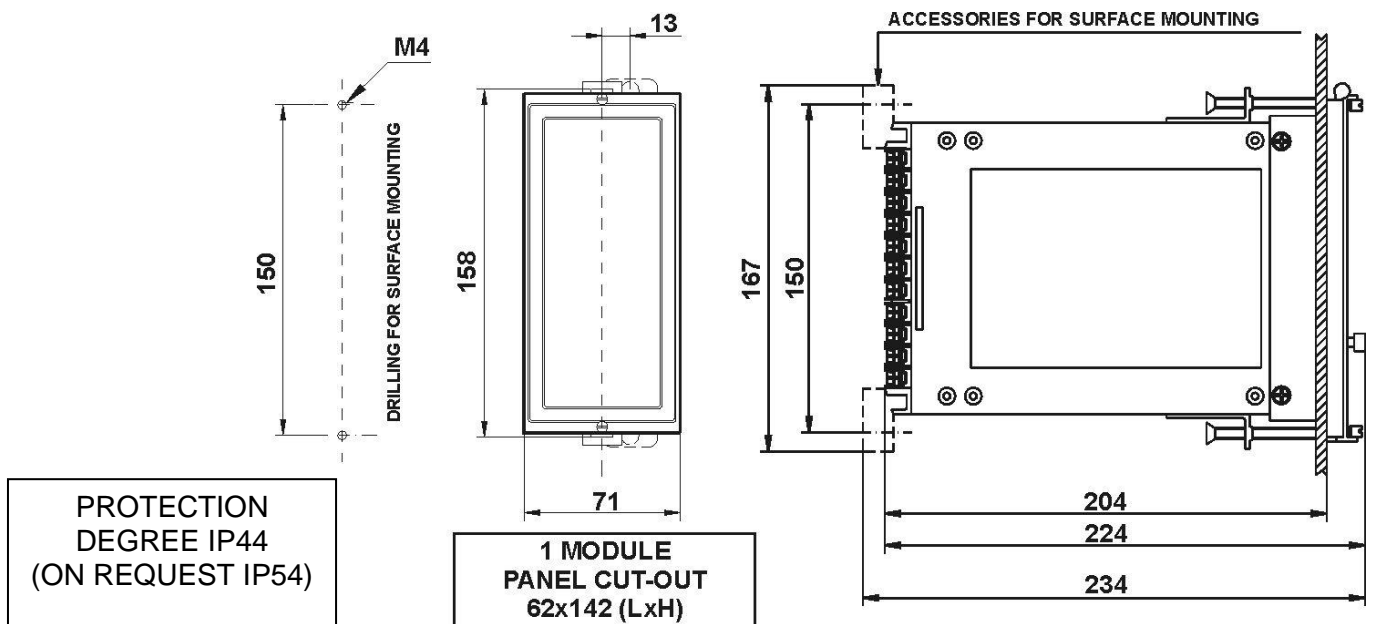

18. DIRECTION FOR PCB'S DRAW-OUT AND PLUG-IN

18.1 - Draw-Out

Rotate clockwise the screws ① in the horizontal position of the screws-driver mark.
 Draw-out the PCB by pulling on the handle ②

18.2 - Plug-In

Rotate clockwise the screws ① in the horizontal position of the screws-driver mark.
 Slide-in the card on the rails provided inside the enclosure.
 Plug-in the card completely and by pressing the handle to the closed position.
 Rotate anticlockwise the screws ① with the mark in the vertical position (locked).

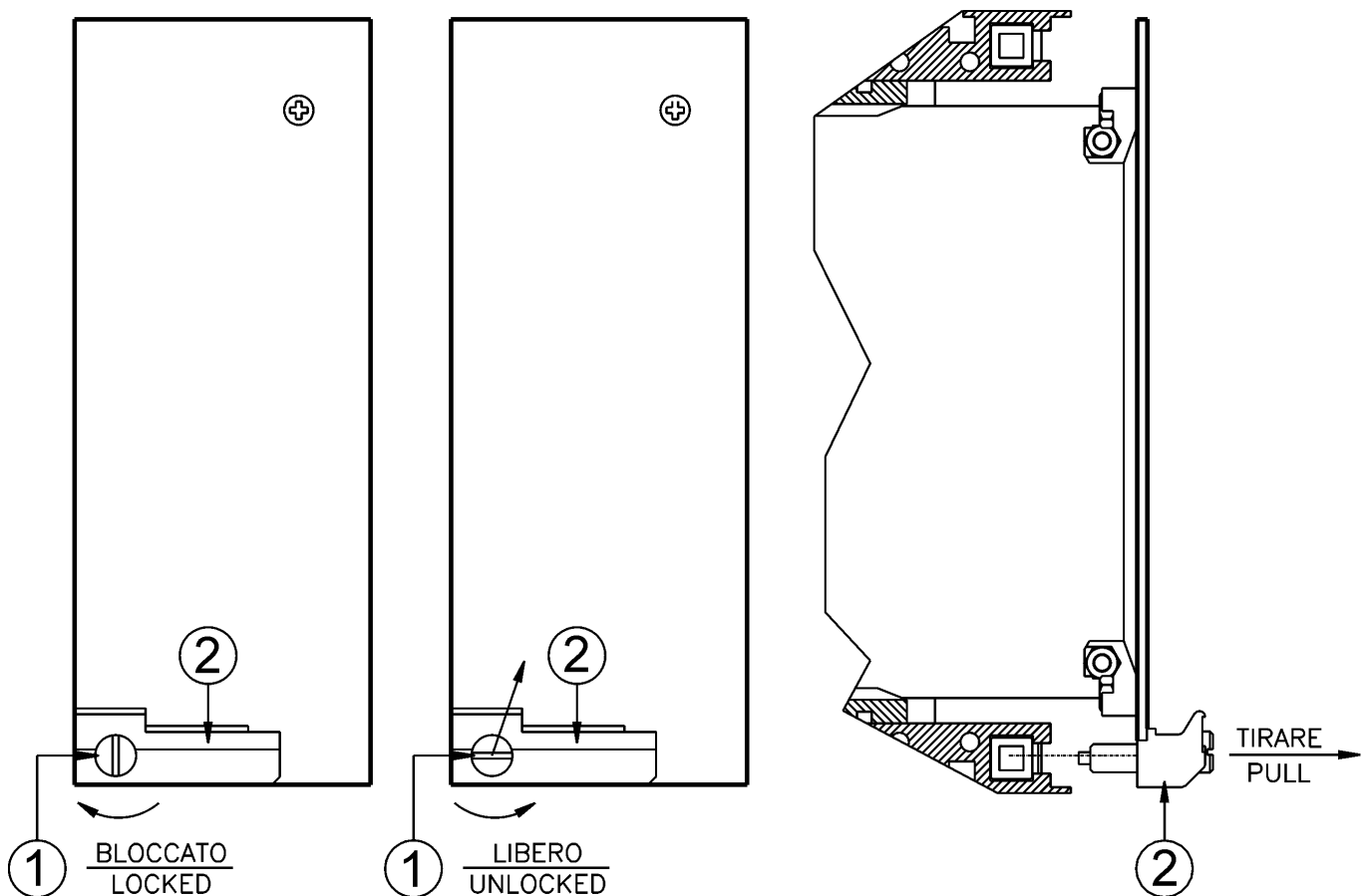

19. ELECTRICAL CHARACTERISTICS

APPROVAL: CE
REFERENCE STANDARDS IEC 60255 - EN50263 - CE Directive - EN/IEC61000 - IEEE C37

<input type="checkbox"/>	Dielectric test voltage	IEC 60255-5	2kV, 50/60Hz, 1 min.
<input type="checkbox"/>	Impulse test voltage	IEC 60255-5	5kV (c.m.), 2kV (d.m.) – 1,2/50µs
<input type="checkbox"/>	Insulation resistance	> 100MΩ	

Environmental Std. Ref. (IEC 60068)

<input type="checkbox"/>	Operation ambient temperature	-10°C / +55°C
<input type="checkbox"/>	Storage temperature	-25°C / +70°C
<input type="checkbox"/>	Environmental testing	(Cold) IEC60068-2-1 (Dry heat) IEC60068-2-2 (Change of temperature) IEC60068-2-14 (Damp heat, steady state) IEC60068-2-78
		RH 93% Without Condensing AT 40°C

CE EMC Compatibility (EN50081-2 - EN50082-2 - EN50263)

<input type="checkbox"/>	Electromagnetic emission	EN55022	industrial environment
<input type="checkbox"/>	Radiated electromagnetic field immunity test	IEC61000-4-3 ENV50204	level 3 80-2000MHz 10V/m 900MHz/200Hz 10V/m
<input type="checkbox"/>	Conducted disturbances immunity test	IEC61000-4-6	level 3 0.15-80MHz 10V
<input type="checkbox"/>	Electrostatic discharge test	IEC61000-4-2	level 4 6kV contact / 8kV air
<input type="checkbox"/>	Power frequency magnetic test	IEC61000-4-8	1000A/m 50/60Hz
<input type="checkbox"/>	Pulse magnetic field	IEC61000-4-9	1000A/m, 8/20µs
<input type="checkbox"/>	Damped oscillatory magnetic field	IEC61000-4-10	100A/m, 0.1-1MHz
<input type="checkbox"/>	Immunity to conducted common mode disturbance 0Hz-150KHz	IEC61000-4-16	level 4
<input type="checkbox"/>	Electrical fast transient/burst	IEC61000-4-4	level 3 2kV, 5kHz
<input type="checkbox"/>	HF disturbance test with damped oscillatory wave (1MHz burst test)	IEC60255-22-1	class 3 400pps, 2,5kV (m.c.), 1kV (d.m.)
<input type="checkbox"/>	Oscillatory waves (Ring waves)	IEC61000-4-12	level 4 4kV(c.m.), 2kV(d.m.)
<input type="checkbox"/>	Surge immunity test	IEC61000-4-5	level 4 2kV(c.m.), 1kV(d.m.)
<input type="checkbox"/>	Voltage interruptions	IEC60255-4-11	
<input type="checkbox"/>	Resistance to vibration and shocks	IEC60255-21-1 - IEC60255-21-2	10-500Hz 1g

ELECTRIC RATED VALUE

<input type="checkbox"/>	Accuracy at reference value of influencing factors (*) $I_n, I_{on} =$ Nominal Current of the System's Current Transformer	2% I_n (*) 0,2% I_{on} (*) 2% + to (to=20÷30ms @ 2xls)	for measure for times
<input type="checkbox"/>	Rated Current	$I_n = 1A/5A - I_{on} = 1A/5A$	
<input type="checkbox"/>	Current overload	500 A for 1 sec; 20A continuous	
<input type="checkbox"/>	Burden on current inputs	Phase : 0.1VA a $I_n = 1A$; 0.3VA a $I_n = 5A$	
<input type="checkbox"/>	Average power supply consumption	≤ 7 VA	
<input type="checkbox"/>	Output relays	rating 6 A; $V_n = 250 V$ A.C. resistive switching = 1500VA (400V max) make = 30 A (peak) 0,5 sec. break = 0.3 A, 110 Vcc, L/R = 40 ms (100.000 op.)	

COMMUNICATION PARAMETER

<input type="checkbox"/>	RS485 (Back)	9600/19200 bps – 8,N,1 - 8,E,1 - 8,O,1 – Modbus RTU or IEC60870-5-103
<input type="checkbox"/>	RS232 (Front)	9600 – 8,N,1 – Modbus RTU

Microelettrica Scientifica S.p.A. - 20089 Rozzano (MI) - Italy - Via Alberelle, 56/68

Tel. (+39) 02 575731 - Fax (+39) 02 57510940 <http://www.microelettrica.com> e-mail : info@microelettrica.com

The performances and the characteristics reported in this manual are not binding and can modified at any moment without notice